

■ Description

FA3630V is a DC-DC converter controller. This IC can directly drive a Nch/Pch-MOSFET. This IC is suitable to reduce converter size because it has many functions in a small package TSSOP.

■ Features

- Low input voltage: 2.5V to 6.5V
- 2-channels PWM control: Rail-to-rail output
Output impedance of output stage = 3.5Ω (typ.)
Nch-MOSFET driving (Ch1)
Nch/Pch-MOSFET driving (Ch2)(selected by SEL pin)
- Low power consumption: 0.7mA (typ.)
- ON/OFF control: Standby current = $0.1\mu\text{A}$ (typ.)
- $\pm 2\%$ high accuracy reference voltage
- Adjustable soft start time and maximum duty cycle
- Adjustable built-in timer latch for short circuit protection
- Wide range of operation frequency: 100kHz to 1MHz
- Package: TSSOP-16 (Thin and small)

■ Applications

- Power supply for general equipment

■ Dimensions, mm

● TSSOP-16

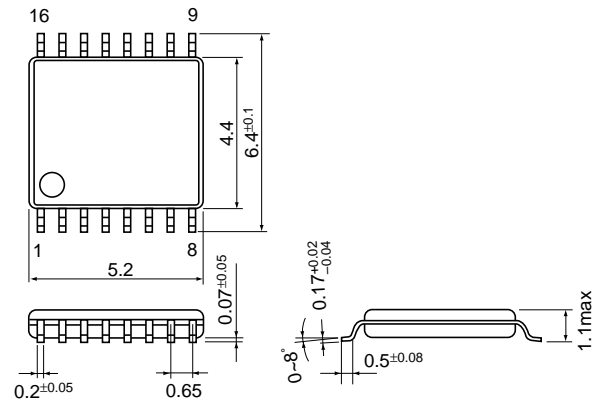

■ Block diagram

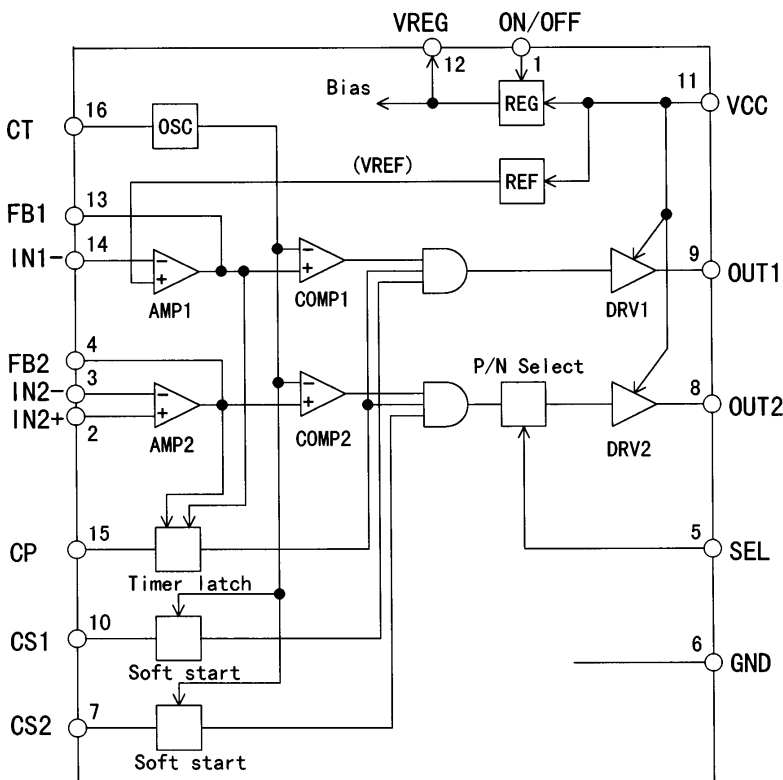

Pin No.	Pin symbol	Description
1	ON/OFF	ON/OFF function
2	IN2+	Ch. 2 non-inverting input to error amplifier
3	IN2-	Ch. 2 inverting input to error amplifier
4	FB2	Ch. 2 output of error amplifier
5	SEL	Selection of type of MOSFET driven
6	GND	Ground
7	CS2	Soft start for Ch. 2
8	OUT2	Ch. 2 output (for Nch or Pch-MOSFET)
9	OUT1	Ch.1 outout (for Nch-MOSFET)
10	CS1	Soft start for Ch.1
11	VCC	Power supply
12	VREG	Regulated voltage output
13	FB1	Ch.1 output of error amplifier
14	IN1-	Ch.1 inverting input to error amplifier
15	CP	Timing capacitor for timer latch delay
16	CT	Oscillator timing capacitor

■ Absolute maximum ratings

Item	Symbol	Rating	Unit
Power supply voltage	V _{CC}	6.5	V
Source peak current of OUT1/2	I _{OUT+}	-500	mA
Sink peak current of OUT1/2	I _{OUT-}	500	mA
Input voltage for logic input	V _{LOG}	-0.3 to +6.5	V
Output current of VREG	I _{REGMAX}	-10	mA
Total power dissipation*	P _d	300	mW
Junction temperature	T _J	125	°C
Ambient temperature	T _{OP}	-20 to +85	°C
Storage temperature	T _{stg}	-40 to +125	°C

* Ta ≤ 25°C

■ Recommended operating conditions

Item	Symbol	Min.	Max.	Unit
Power supply voltage	V _{CC}	2.5	5.5	V
Input voltage for logic input	V _{LOG}	0	5.5	V
Oscillation frequency	f _{osc}	100	1000	kHz

■ Electrical characteristics (V_{CC}=3.3V, Ta=25°C, C_T=100pF)

Regulated voltage section for internal control blocks

Item	Symbol	Test condition	Min.	Typ.	Max.	Unit
Regulated voltage	V _{REG}	I _{REG} =no load	2.156	2.200	2.244	V
Variation with output current	V _{RGOUT}	V _{REG} =0 to 5mV			5	mV
Variation with supply voltage	V _{RGLIN}	V _{CC} =2.5 to 5.5V			8	mV
Variation with temperature	V _{RGTa}	Ta=-20 to +25°C		±0.5		%
		Ta=+25 to +85°C		±0.5		%

Reference voltage section

Item	Symbol	Test condition	Min.	Typ.	Max.	Unit
Reference voltage	V _{REF}		0.98	1.00	1.02	V
Variation with supply voltage	V _{RGLIN}	V _{CC} =2.5 to 5.5V		1	5	mV
Variation with temperature	V _{RGTa}	Ta=-20 to +25°C		±0.5		%
		Ta=+25 to +85°C		±0.5		%

Oscillator section

Item	Symbol	Test condition	Min.	Typ.	Max.	Unit
Oscillation frequency	f _{osc}	C _T =100pF	437	485	533	kHz
High level voltage	V _{OSCH}	C _T =100pF		1.39		V
Low level voltage	V _{OSCL}	C _T =100pF		0.77		V
Variation with supply voltage	f _{dV}	V _{CC} =2.5 to 5.5V		±1	±5	%
Variation with temperature	f _{dT}	Ta=-20 to +25°C		±5		%
		Ta=+25 to +85°C		±5		%

Error amplifier section

Item	Symbol	Test condition	Min.	Typ.	Max.	Unit
Input offset voltage	V _{IOF}			3	10	mV
Common mode input voltage	V _{ICOM}		0.2		1.5	V
DC open loop gain	A _{VOL}		70	75		dB
Unity gain band width	f _T			1.6		MHz
Output sink current	I _{FBL}	V _{FB} =0.5V	2.0	2.5	3.0	mA
Output source current	I _{FBH}	V _{FB} =V _{REG} -0.5V	-160	-125	-90	μA

ON/OFF logic input signal section

Item	Symbol	Test condition	Min.	Typ.	Max.	Unit
Input range for ON mode	VONH	V _{CC} =2.5V to 5.5V	2.0			V
Input range for OFF mode	VONL	V _{CC} =2.5V to 5.5V			0.5	V

SEL logic input signal section

Item	Symbol	Test condition	Min.	Typ.	Max.	Unit
Input range for driving Nch-MOSFET	VSELH		V _{CC} -0.5			V
Input range for driving Pch-MOSFET	VSELL				0.5	V

Timer latch protection section

Item	Symbol	Test condition	Min.	Typ.	Max.	Unit
Threshold voltage of CP	V _{CPTH}		1.55	1.70	1.85	V
Charge current of CP	I _{CP}	V _{CP} =V _{REG} -0.5V	-2.5	-2.1	-1.7	μA
Threshold voltage of FB1/FB2	V _{FBTL}		1.56	1.73	1.90	V

Soft-start section

Item	Symbol	Test condition	Min.	Typ.	Max.	Unit
Threshold voltage of CS1/2	V _{CS 0}	Duty cycle=0%	0.74	0.79	0.84	V
Threshold voltage of CS1/2	V _{CS 100}	Duty cycle=100%	1.29	1.34	1.39	V

Output section

Item	Symbol	Test condition	Min.	Typ.	Max.	Unit
ON resistance	OUT1 (High / Low) OUT2 (High / Low)	I _{OUT} =±100mA V _{CC} =3.3V		3.5	7	Ω
				3.5	7	Ω
Rise time	OUT1 OUT2	C _{LOAD} =1000pF V _{CC} =3.3V		25	35	ns
				25	35	ns
Fall time	OUT1 OUT2	C _{LOAD} =1000pF V _{CC} =3.3V		25	35	ns
				25	35	ns

Overall device

Item	Symbol	Test condition	Min.	Typ.	Max.	Unit
Standby current	I _{CC0}	ON/OFF=GND		0.1	5	μA
Operating average current	I _{CC}	OUT1, OUT2: Open Output duty=100%		0.7	1	mA
	(Reference value)	OUT1, OUT2: Open IN- and FB: Shorted		1.5		mA

■ Characteristic curves (Ta=25°C)

Supply current (I_{CC}) vs. supply voltage (V_{CC})

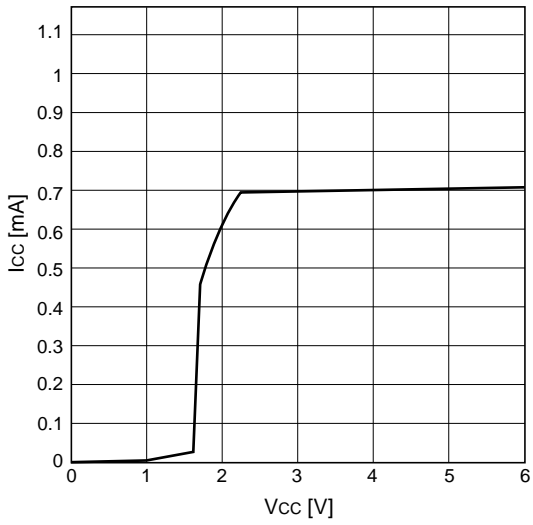

Oscillation frequency (f_{osc}) vs. timing capacitor (C_T)

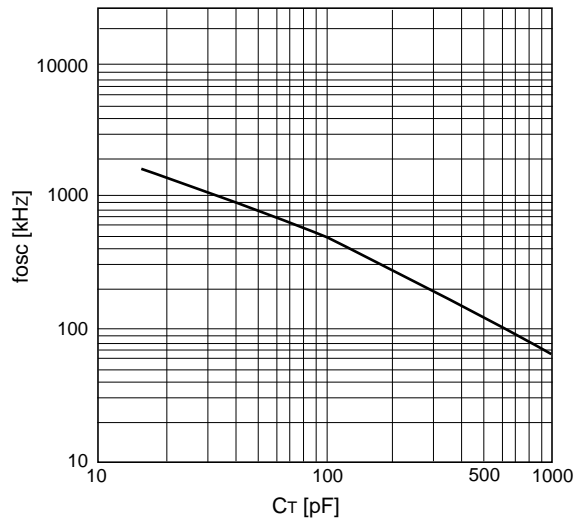

Output duty cycle vs. FB terminal voltage (V_{FB})

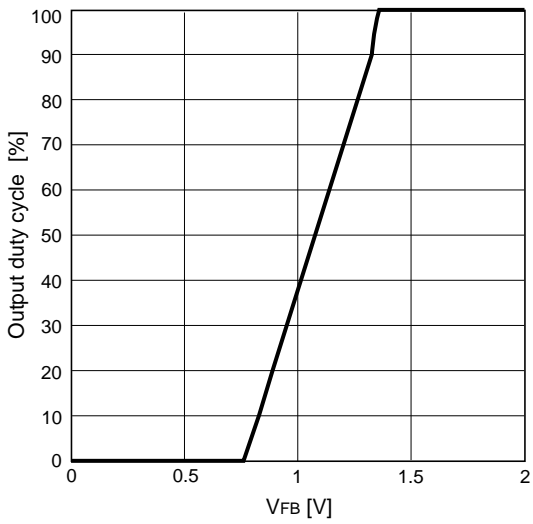

Output duty cycle vs. CS terminal voltage (V_{CS})

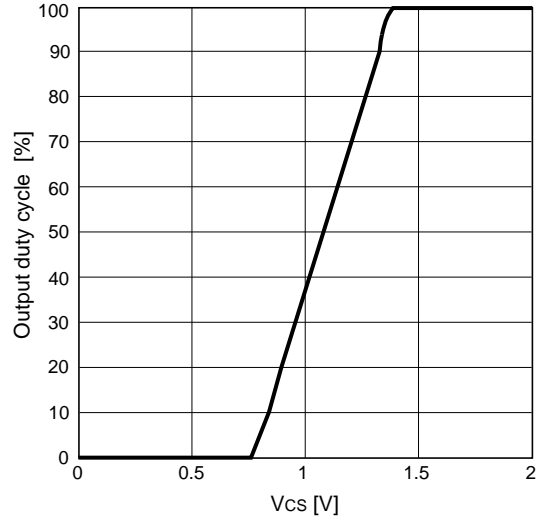

Oscillation frequency (f_{osc}) vs. ambient temperature (T_a)

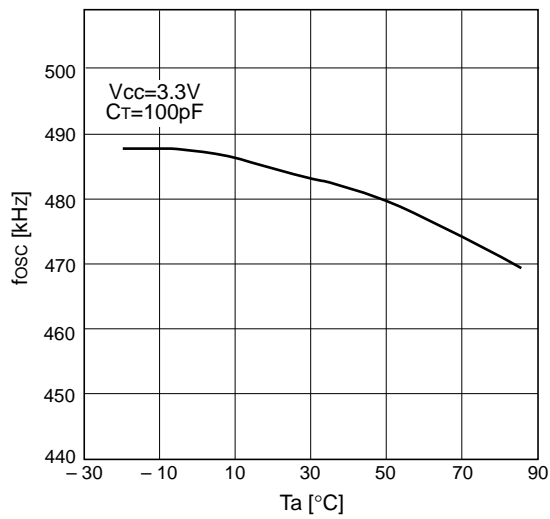

Reference voltage (V_{REF}) vs. ambient temperature (T_a)

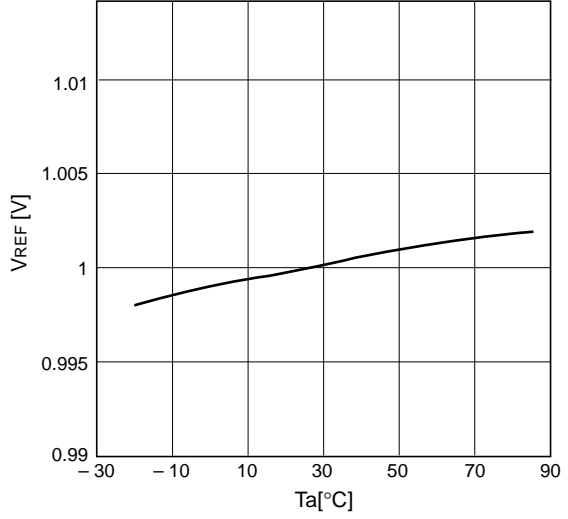

L-level output voltage (VOL1) vs. output sink current (ISINK1)

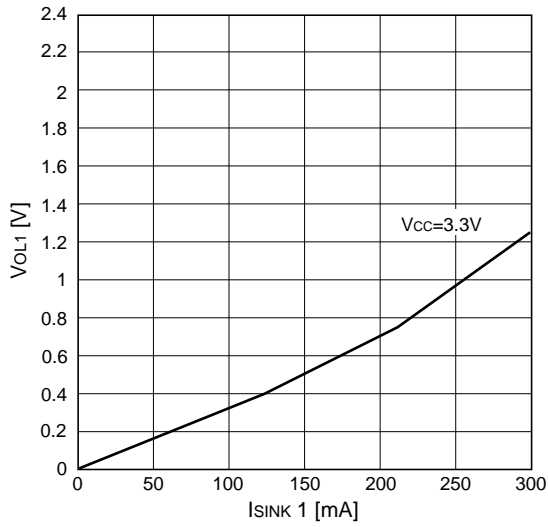

H-level output voltage (VOH1) vs. output source current (ISOURCE1)

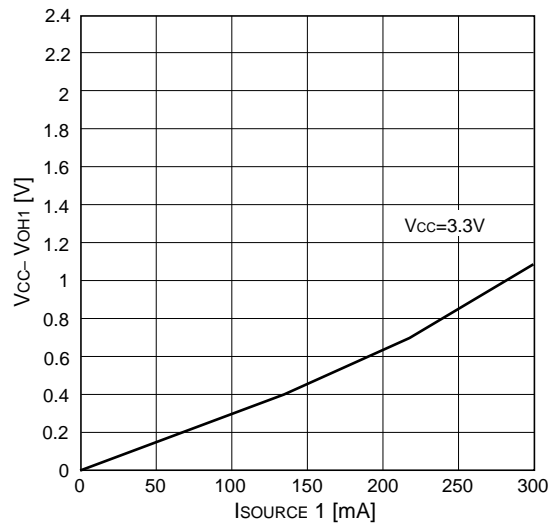

L-level output voltage (VOL2) vs. output sink current (ISINK2)

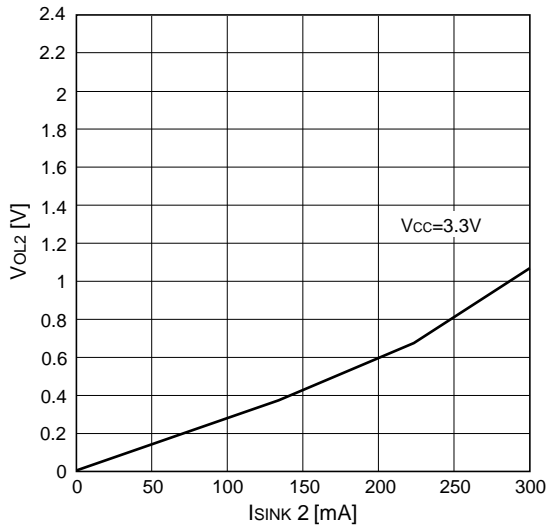

H-level output voltage (VOH2) vs. output source current (ISOURCE2)

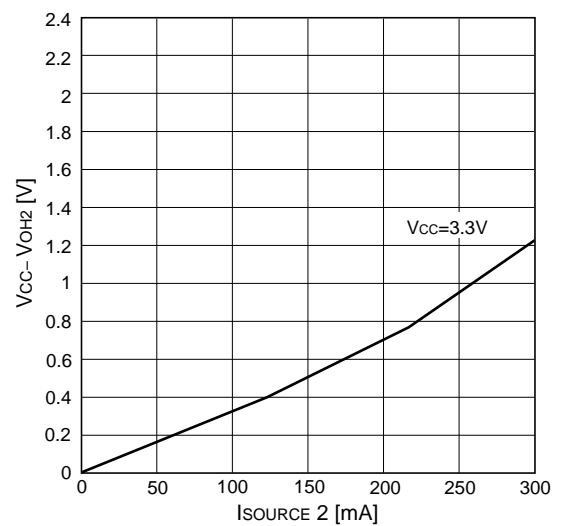

Error amplifier voltage gain (Av) / phase (θ) vs. frequency (f)

Condition: Open loop

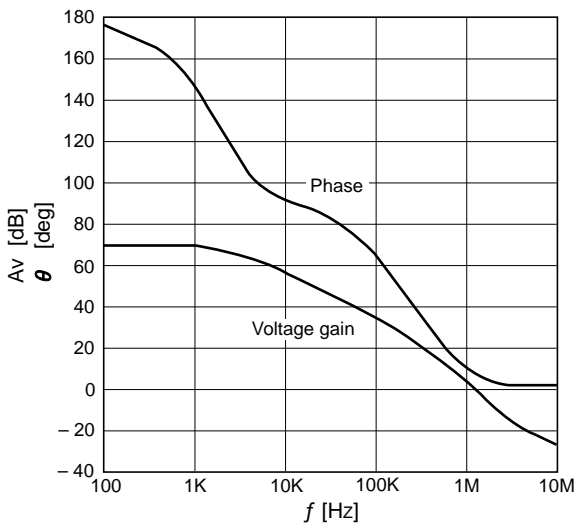

■ Application circuit

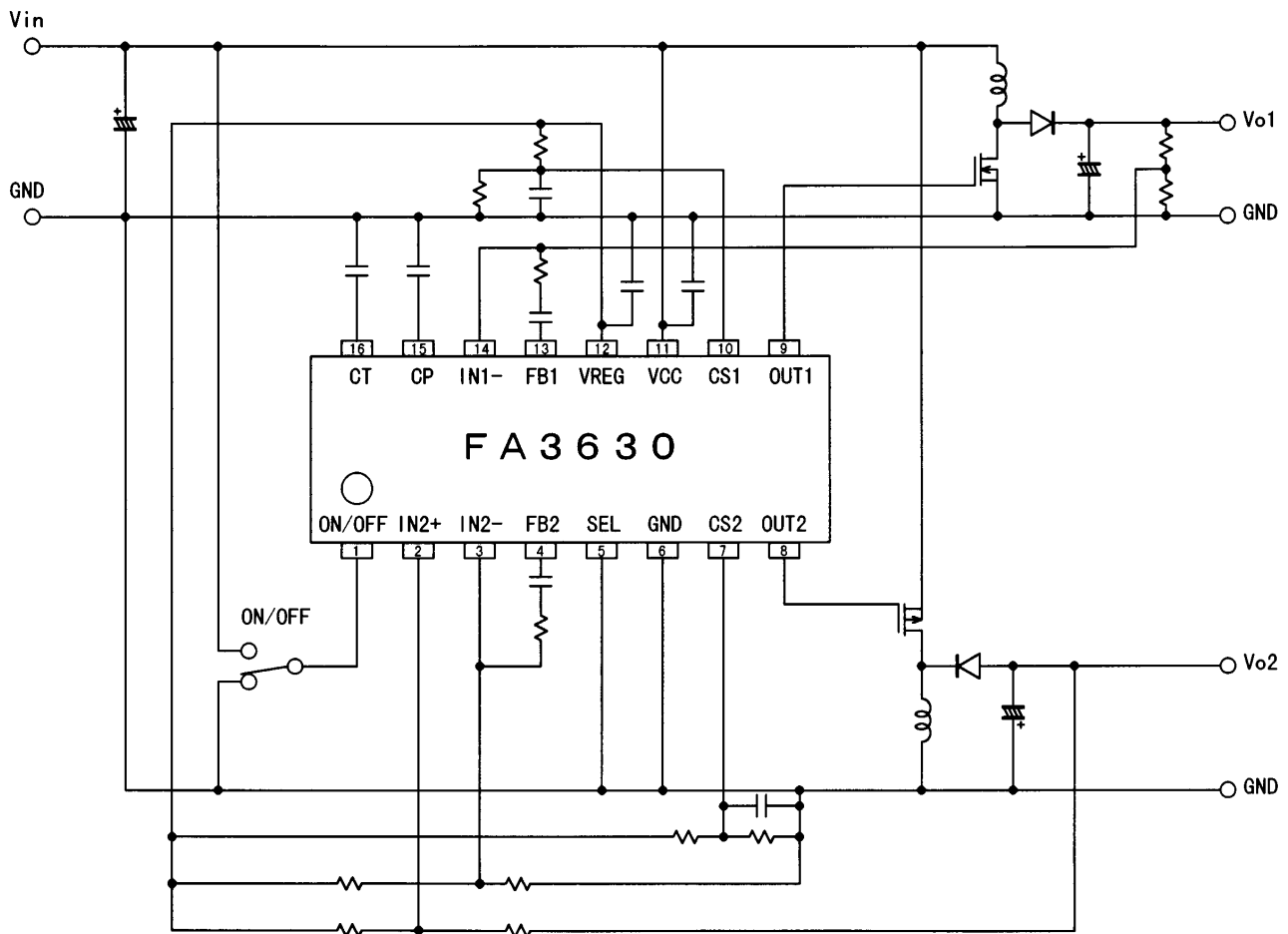

Parts tolerances characteristics are not defined in the circuit design sample shown above. When designing an actual circuit for a product, you must determine parts tolerances and characteristics for safe and economical operation.

WARNING

1. This Data Book contains the product specifications, characteristics, data, materials, and structures as of September 1999. The contents are subject to change without notice for specification changes or other reasons. When using a product listed in this Data Book, be sure to obtain the latest specifications.
2. All applications described in this Data Book exemplify the use of Fuji's products for your reference only. No right or license, either express or implied, under any patent, copyright, trade secret or other intellectual property right owned by Fuji Electric Co., Ltd. is (or shall be deemed) granted. Fuji makes no representation or warranty, whether express or implied, relating to the infringement or alleged infringement of other's intellectual property rights which may arise from the use of the applications described herein.
3. Although Fuji Electric is enhancing product quality and reliability, a small percentage of semiconductor products may become faulty. When using Fuji Electric semiconductor products in your equipment, you are requested to take adequate safety measures to prevent the equipment from causing a physical injury, fire, or other problem if any of the products become faulty. It is recommended to make your design fail-safe, flame retardant, and free of malfunction.
4. The products introduced in this Data Book are intended for use in the following electronic and electrical equipment which has normal reliability requirements.
 - Computers • OA equipment • Communications equipment (terminal devices) • Measurement equipment
 - Machine tools • Audiovisual equipment • Electrical home appliances • Personal equipment • Industrial robots etc.
5. If you need to use a product in this Data Book for equipment requiring higher reliability than normal, such as for the equipment listed below, it is imperative to contact Fuji Electric to obtain prior approval. When using these products for such equipment, take adequate measures such as a backup system to prevent the equipment from malfunctioning even if a Fuji's product incorporated in the equipment becomes faulty.
 - Transportation equipment (mounted on cars and ships) • Trunk communications equipment
 - Traffic-signal control equipment • Gas leakage detectors with an auto-shut-off feature
 - Emergency equipment for responding to disasters and anti-burglary devices • Safety devices
6. Do not use products in this Data Book for the equipment requiring strict reliability such as (without limitation)
 - Space equipment • Aeronautic equipment • Atomic control equipment
 - Submarine repeater equipment • Medical equipment
7. Copyright ©1995 by Fuji Electric Co., Ltd. All rights reserved.
No part of this Data Book may be reproduced in any form or by any means without the express permission of Fuji Electric.
8. If you have any question about any portion in this Data Book, ask Fuji Electric or its sales agents before using the product. Neither Fuji nor its agents shall be liable for any injury caused by any use of the products not in accordance with instructions set forth herein.